



Quality - Built In

# ASSEMBLY INSTRUCTIONS



## KL1

BASE SIZE 1715mm x 1210mm

# ASSEMBLY INSTRUCTIONS

## Tools Required:

- Drill
- Drill Bit 3.5mm
- Drill Bit 6mm (for clear roof panel only)
- Hex Drive 5/16
- Riveter
- Hammer
- Nail Punch
- Tape Measure
- Ladder or Saw stool
- Spanners x 2
- String Line
- Tin Snips
- Skillsaw and Jigsaw (for floor only)
- Masonry Drill and 10mm Masonry Bit (for Bolt Down Kit only)

## Before you start:

- Read all instructions carefully.
- Identify all parts and check quantities against checklist.
- If you are making your own floor refer to Raised Base Plate section now.

## Safety:

- Do not attempt to build your shed in high winds.
- Beware of sharp edges.
- Protect your eyes and ears.
- Use electric tools with care. Use a Safety Trip Switch.
- It is easier and quicker if this shed is erected by two people.

## Select your site:

- Your shed must be level. Achieve this by either levelling the ground or by using blocks.
- If your shed is to be positioned on wet or damp ground, we recommend that your shed is raised up off the ground slightly.

# KIWI KL 1 PARTS LIST



ROOF COLOUR  WALL COLOUR  INVOICE NO:  BASE SIZE: 1.715 X 1.210

## STANDARD SHED KITSET

QTY	LENGTH	DESCRIPTION	PACKED	CHECKED
5	1.890m	Wall Sheets	<input type="checkbox"/>	<input type="checkbox"/>
2	1.890m	1/2 Wall Sheets	<input type="checkbox"/>	<input type="checkbox"/>
2	1.450m	Roof Sheets	<input type="checkbox"/>	<input type="checkbox"/>
1		Door - Standard <input type="checkbox"/> Security <input type="checkbox"/>	<input type="checkbox"/>	<input type="checkbox"/>
1		Instruction Booklet	<input type="checkbox"/>	<input type="checkbox"/>
1		Hardware Pack	<input type="checkbox"/>	<input type="checkbox"/>
		Touch-up Paint & Brush	<input type="checkbox"/>	<input type="checkbox"/>

## OPTIONAL EXTRAS

QTY	LENGTH	DESCRIPTION	PACKED	CHECKED
84	50mm	Flooring Nails	<input type="checkbox"/>	<input type="checkbox"/>
6	75mm	Flooring Nails	<input type="checkbox"/>	<input type="checkbox"/>
<b>WINDOWS</b>				
		Fixed Window Frame	<input type="checkbox"/>	<input type="checkbox"/>
	0.580m	Glaze Beads	<input type="checkbox"/>	<input type="checkbox"/>
	0.603 x 0.603m	Glass	<input type="checkbox"/>	<input type="checkbox"/>
		Louvre Window Frame	<input type="checkbox"/>	<input type="checkbox"/>
	0.588 x 0.150m	Glass	<input type="checkbox"/>	<input type="checkbox"/>
1		Window Hardware Pack	<input type="checkbox"/>	<input type="checkbox"/>
<b>CLEAR ROOF PANEL</b>				
	1.450m	Clear Roof Panel	<input type="checkbox"/>	<input type="checkbox"/>
	1.450m	Roof Sheet	<input type="checkbox"/>	<input type="checkbox"/>
<b>SECURITY PARTS</b>				
		Security Single Door Hardware Pack	<input type="checkbox"/>	<input type="checkbox"/>
		Alarm - MA20	<input type="checkbox"/>	<input type="checkbox"/>
		Shed light	<input type="checkbox"/>	<input type="checkbox"/>
		Peg Down Kit	<input type="checkbox"/>	<input type="checkbox"/>
		Bolt Down Kit	<input type="checkbox"/>	<input type="checkbox"/>

DATE: / /

PACKED BY:

CHECKED BY:

Total Weight

kg

# KL1 TIMBER FRAME

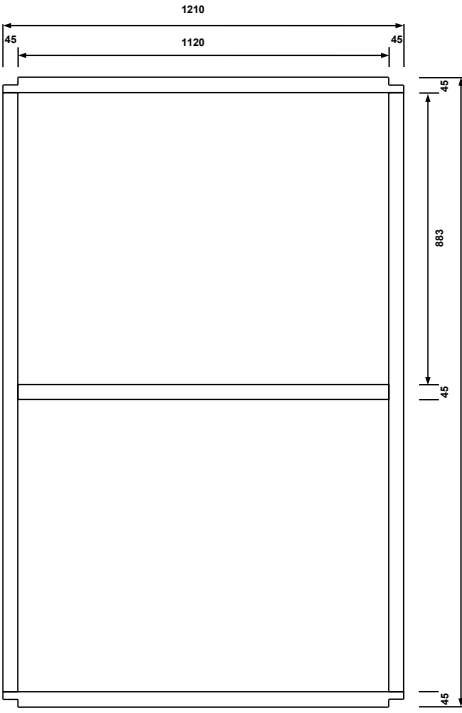
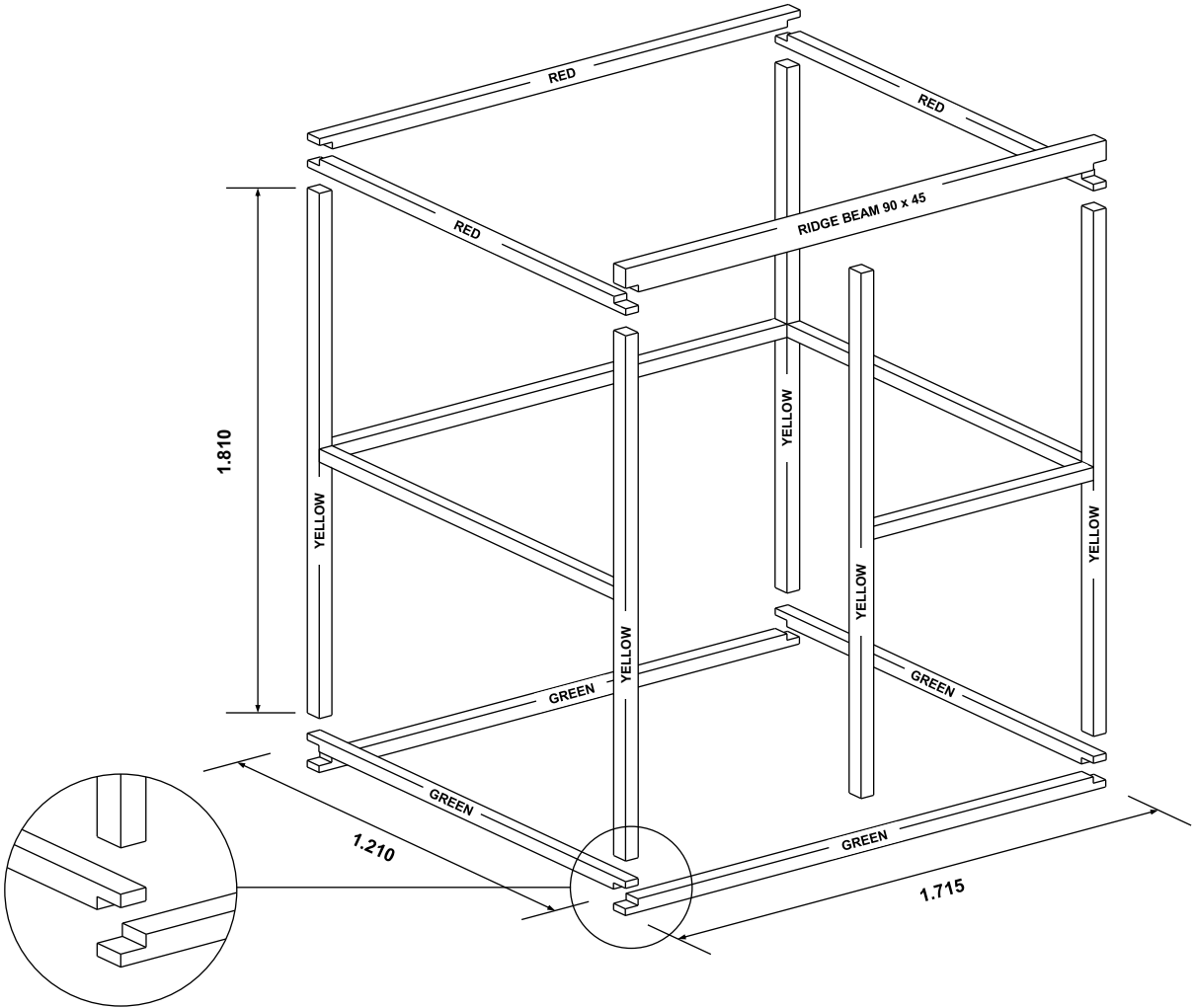

END WALL

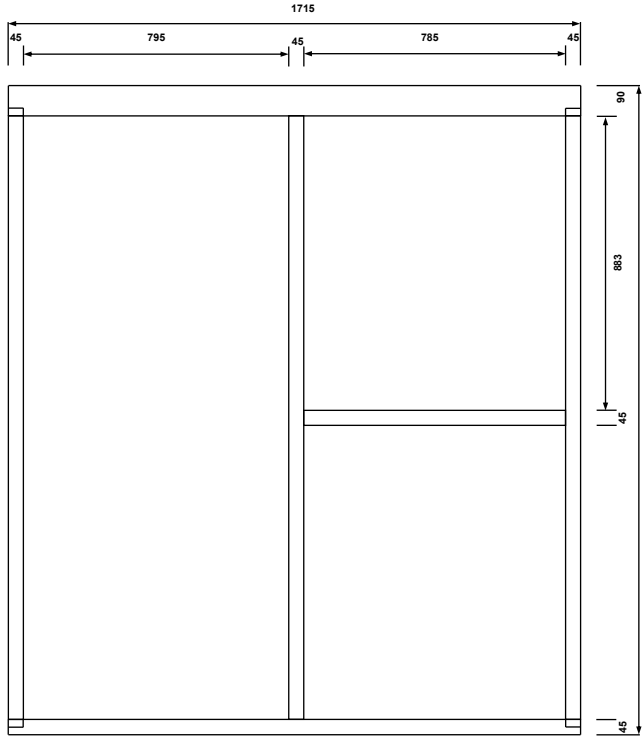

FRONT WALL

# KL1 TIMBER FRAME

**Note:** For sheds with the Raised Floor Modification option the studs will be 1.780m long to allow the Wall Sheets to protrude 20mm below the Bottom Plate. Refer to Raised Floor Modification section (Page 15).

**Note:** Studs and Nogs surrounding a window opening are to be fitted once the wall cladding is nailed in place.

**Step 1: End Walls:** Select one 1.210m End Base Plate (Green), one 1.210m End Top Plate (Red) and two Studs (Yellow). Lay out Plates and two Studs on a flat surface and nail together using two 75mm nails per join. Position 1.120m Nog .883m down from Top Plate and nail in place. Repeat with other end wall.

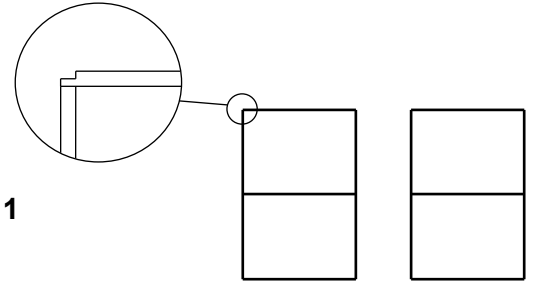

**Step 2:** Select one 1.715m Base Plate (Green), one 1.715m Top Plate (Red). Stand up End frame with the Stud side of the frame on the ground. Nail 1.715m plates to frame using two nails per join. Ensure Green joins to Green and Red joins to Red. Repeat with other end frame. Position 1.625m Back Wall Nog .883m down from the Top Plate and nail in place.

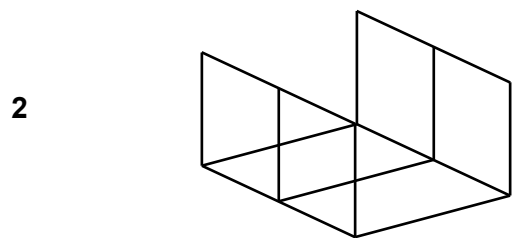

**Step 3:** Select one 1.715m Base Plate (Green) and the Ridge Beam (90 x 45). Nail in place. Ensure Green joins to Green.

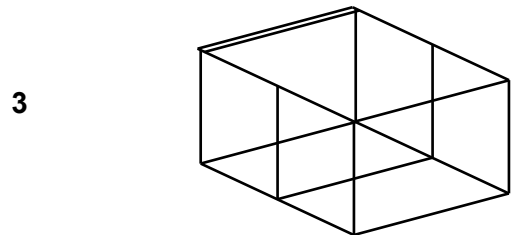

**Step 4:** Carefully roll the frame over so that the Ridge Beam and Base Plate (Green) are on the ground. Select a stud (Yellow) and one .785m Nog. Nail in Stud using the .785m nog to get the correct position top and bottom. Position nog .883m down from the Top Plate and nail in place.

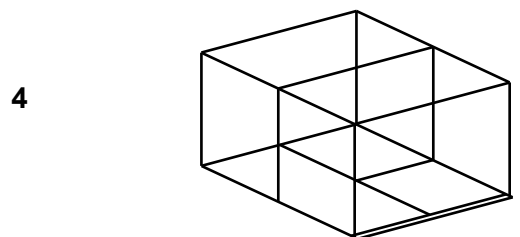

**Step 5:** Carefully roll frame over onto its base. If fitting a Kiwi Floor, fit Floor Joists now. Place the joist centrally and nail in place using three 75mm nails per end.

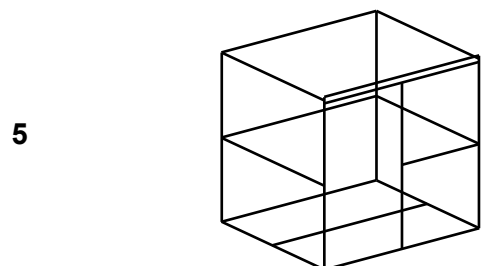

# KL1 WALL CLADDING

## TO AVIOD CORROSION:

- Where at all possible try not to trap metal filings between two sheets. Remove all metal filings before riveting.
- Carbon in pencils reacts with the Zinc/Aluminium coating on steel. Use either crayon or ink to mark steel.

## TERMS EXPLANATION

- **To Tack:** To Tack on a wall sheet means to use minimum nails hammered partly in to hold Wall Sheets in position. Should a Wall Sheet need to be re-positioned, the nails can easily be prized out.
- If a window is required, identify Wall Sheet(s) with window hole pre-cut. Lean up Wall Sheets where window(s) are to be located.

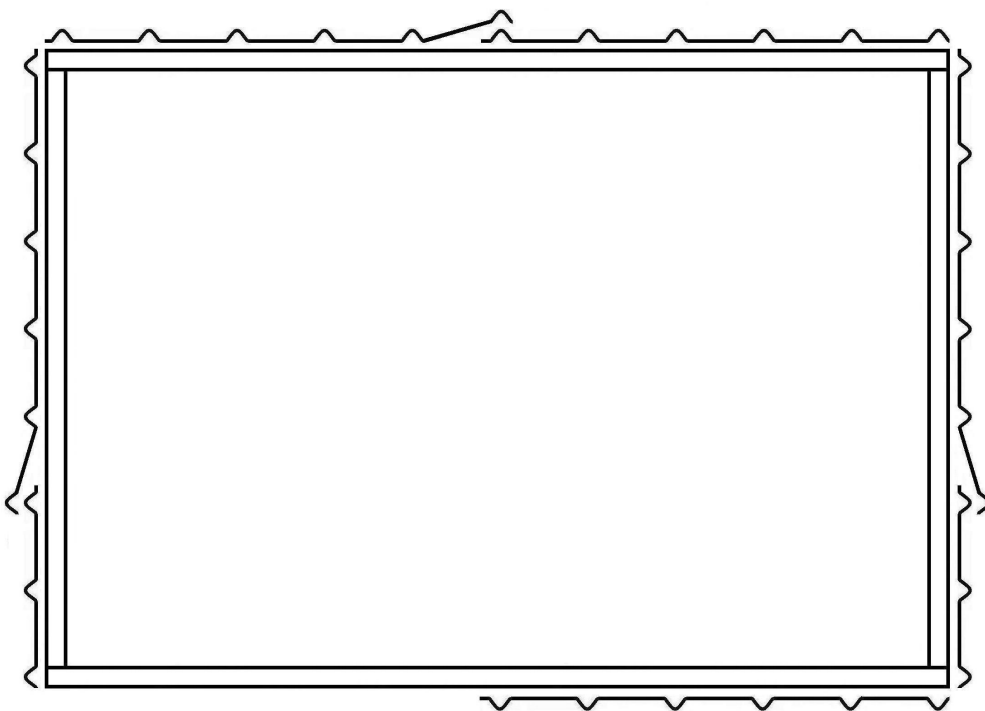

**CLADDING DETAIL**  
**Birds Eye View**

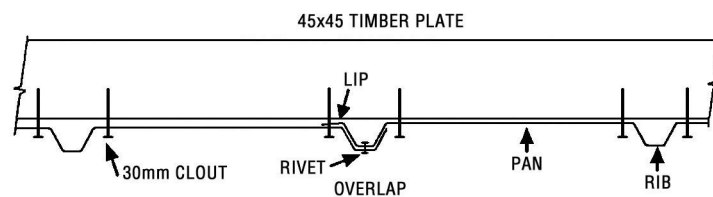

**fig. 1**

# KL1 WALL CLADDING

**Step 1: Front Wall:** Position wall on the right hand side of the doorway with the sheet LIP on the left hand side. Ensuring the LIP is flush with the side of the Stud and the top is 45mm below the top of the Ridge Beam, tack in place.

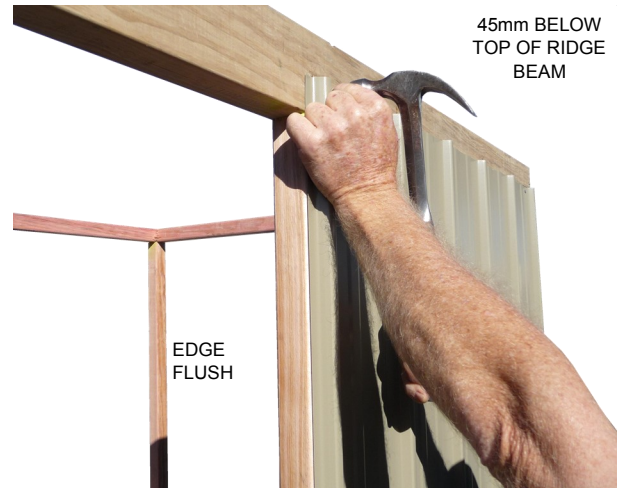

**Step 2: Back Wall:** Position the first Wall Sheet with the LIP on the right hand side. Ensuring the LIP is flush with the side of the corner Stud and the top of the Wall Sheet is flush with the top of the Top Plate, tack in place. Position the next Wall Sheet with the LIP on the right hand side. Overlap as shown in **fig 1**. Ensuring Wall Sheet is flush with top of Top Plate, tack in place.



**Step 3: End Walls:** Position wall sheet with the LIP flush with the side of the stud and the top of the Wall Sheet is flush with the top of the Top Plate, tack in place. Tack in remaining 1/2 Wall Sheet. Repeat with the other end. If fitting a window, nail in Window Studs and Nog now. Refer to Window instructions.



**Step 4: Nailing Off:** Nail one 30mm Clout each side of the Rib (two per Pan) into the Top Plates and Bottom Plates. Nail Wall Sheets to mid wall Nogs (one per pan). Nail each corner Wall Sheet to Studs using two 30mm Clouts evenly spaced.

# KL1 WINDOW (Optional)

## LOUVRE WINDOW

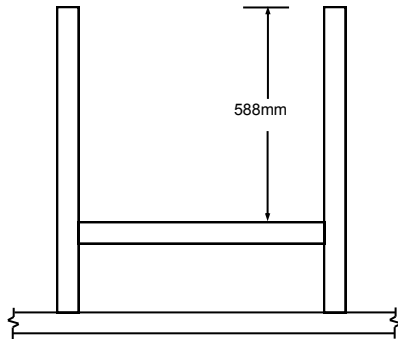

**Step 1:** Lay out the two window studs (883mm) and Nog (634mm) on a flat surface. Position Nog and nail in place using 2x 75mm nails at each end.



**Step 2:** On the inside of the shed, position studs and Nog centrally on window opening. Make sure the studs are parallel and nail into Top Plate and End Wall Nog.

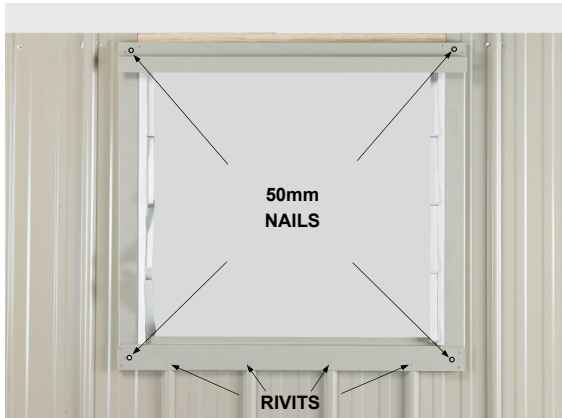

**Step 3:** Nail wall Sheets to window framing using 30mm clouts. (return to step 4 on page 7 and complete). Then fit Window Frame). Position Window Frame centrally on window opening and rivet it to ribs. Pre-drill holes in each corner and nail Window Frame to framing, using 50mm nails.



**Step 6:** From the inside of the shed, slide Louvre Glass into Louvre Units attached to the Window Frame. Bend up tabs to keep Glass in position.

## FIXED WINDOW

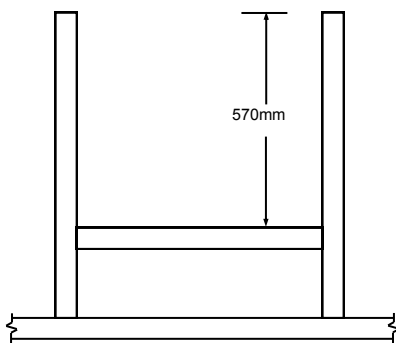

**Step 1:** Lay out the two window studs (883mm) and Nog (590mm) on a flat surface. Position Nog and nail in place using two 75mm nails at each end.



**Step 6:** From the outside of the shed, place glass in Window Frame. Attach a Glazing Bead (G100) with three rivets to each side of the Window Frame to hold glass in place. Pre-drilling Glazing Beads is recommended.



# KL1 DOOR JAMB & CORNER FLASHINGS



**Step1:** Fit Door Jamb Flashing (104) in between Top and Bottom Plates and hard against Stud. Attach Door Jamb Flashing with three rivets into Rib on the outside and three 30mm clouts into studs on the inside. Repeat with the other Door Jamb.

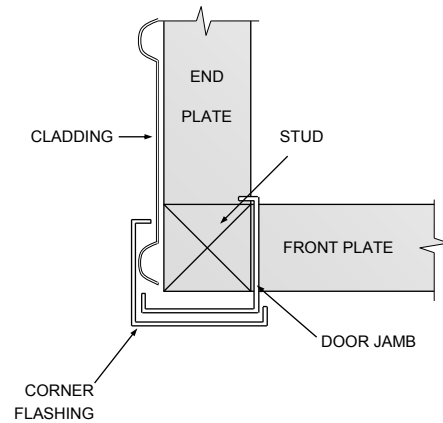

**Step 2:** On the left hand side of the front wall fit Corner Flashing (101) over Door Jamb Flashing and rib . With top of the Corner Flashing flush with the top of the Top Plate, rivet in place using six rivets.



**Step3:** Measure and cut Doorstep Flashing (106) to fit in between Door Jambs. Position the Doorstep Flashing in between the Door Jambs at bottom of doorway, nail through top of flashing using three 30mm Clouts. Repeat with the Overdoor Flashing (105).



**Step 4:**Fit remaining three Corner Flashings over corner Ribs and rivet in place using six rivets per flashing. When fitting right hand Corner Flashing on the front wall, ensure it is parallel with the Door Jamb.



**Step 5:**Position Ridge Cover (A109) on Ridge Beam. While holding straight and square, nail top of Ridge Cover Flashing to Ridge Beam using three 30mm clouts. Rivet front of Ridge Cover to Ribs and Flashings using seven rivets.

# KL1 ROOF

**Note:** Condensation can form on the under side of shed roof. If building paper is required, fit now. Building paper will need to be supported by netting or roofing twine.

**Roof with Clear Panel:** Handle Clear Panel with care. The Clear Panel will crack if not fitted correctly.  
Riveting: Pre-drill 3.5mm hole through Clear Panel and Steel. Enlarge hole in Clear Panel with drill to allow for expansion and contraction.

Screwing: Pre-drill a 6mm hole through the Clear panel.

**Step 1:** Check that the diagonal measurements of the shed are the same. If building on unlevel ground it may be necessary to temporarily brace the shed with pieces of timber from the packaging.

**Step 2:** Position first Roof Sheet on the right hand side of the shed with the LIP on the left hand side. Position the next Roof Sheet. Ensure it overlaps correctly (when fitting a Clear Roof Panel, ensure it OVERLAPS Roof Sheet). Rivet sheet joins 500mm from edge, front and back.



**Step 3:** Position roof so that the front overhang measures 140mm. Line up Ribs on the Roof Sheets with Ribs on the Wall Sheets. Ensure plates are straight then screw roof to Top plates using one 50mm Roofing Screw on each Rib front and back.

(Using 4 x 50mm galv clouts, nail clouts on the outside ribs only, as these are covered by the Barge flashing.

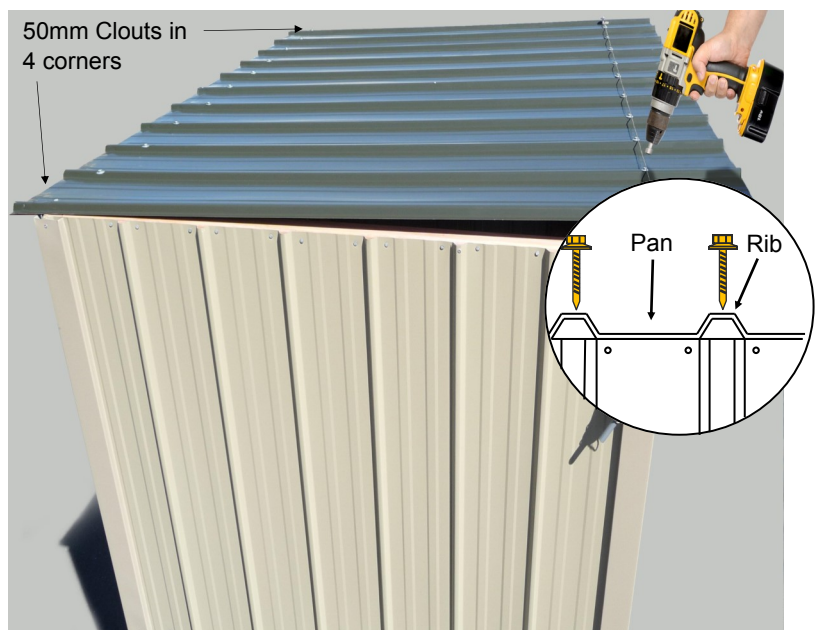

# KL1 DOOR

**Step 1:** Position Door Track (107) on front wall 55mm down from underside of Roof, with right hand end flush with the right hand corner. Pre-drill hole in centre and rivet in place. Remove ALL drill filings

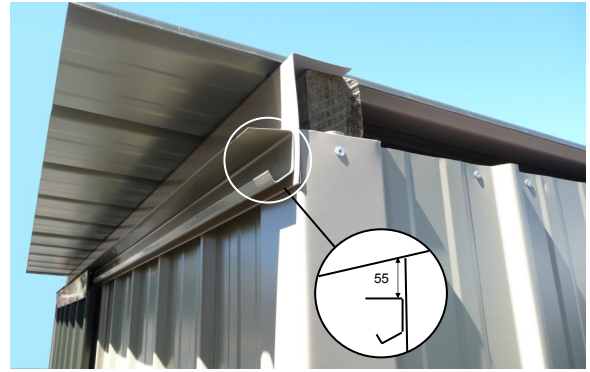

**Step 2:** Hang door in Door Track. At the right hand end of Door Track, adjust up or down so that the Door hangs parallel with shed. Fit one rivet at right hand end to hold in place. Repeat with left hand end of track.



**Step 3:** Remove Door. Pre-drill holes into each Rib and at similar spacings into Over Door Flashing. At approximately 1/3 in from each end of Door Track put a 50mm nail. Fix rivets to rest of holes



**Step 4:** Clean out ALL drill filings. Also make sure the Wheels are cleaned of drill filings. Re-hang Door, then insert door stops into the pre drilled holes at end of tracks as shown in diagram. Tighten with two spanners.

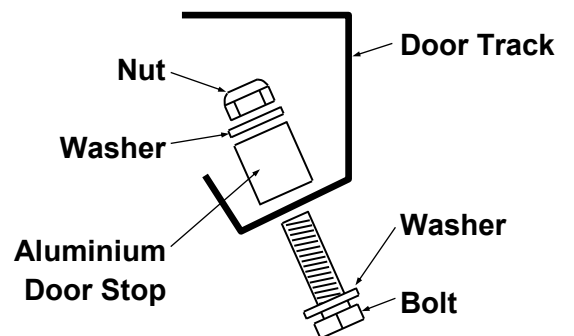

# KL1 DOOR

**Step 5:** Bottom Door Guide: Slide Door to corner. Hang Door Guide (108) on bottom of the Door. Make it flush with Corner Flashing. Lift up approximately 3mm so that the Door will Slide freely. Pre-drill hole and nail in place using a 50mm nail. Slide to centre. Ensuring Door slides freely, pre-drill hole and nail Door Guide in place. Check Door is not binding in the middle then pre-drill holes into each Rib at similar spacing into Door Step Flashing. Nail off using 50mm nails.

**Note:** For sheds with Raised Base Plate option the Door Step Flashing will protrude down past the Bottom Plate. Attach Door Guide with rivets.

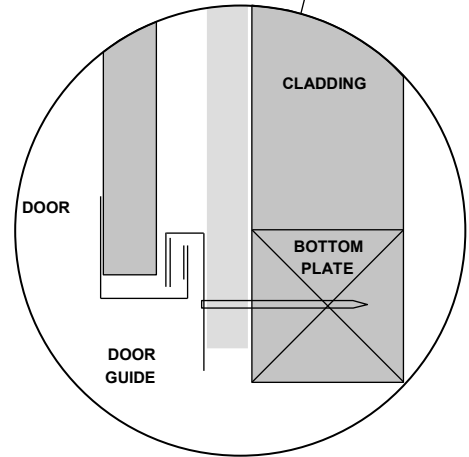

# KL1 BARGE & SPOUTING

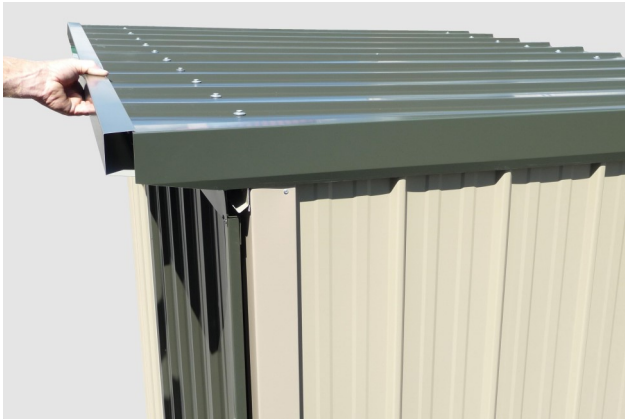

**Step 1:** Position Barge Flashing (G102) on gable ends. Position a Spouting (A103) and rivet to the Barge Flashing at each end. Repeat with other Spouting.



**Step 2:** Centralise Barge Flashing on end and rivet in place, one rivet into every second Rib. Fit two rivets through top of Barge into Rib. Repeat with other Barge Flashing. Check Spoutings are straight, then rivet to Roof one rivet every second Rib.

# KL1 FLOOR (Optional)

**Step 1:** Place shed in final position. Check the diagonal measurements are the same and the shed is level before fitting Floor. It is recommended that the shed is anchored down with either a Duratuf Bolt Down Kit or Duratuf Peg Down Kit depending on what the shed is sited on.

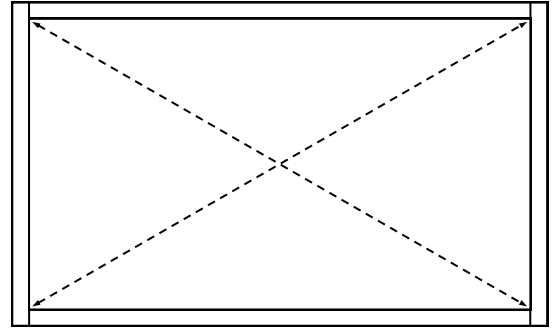

**Step 2:** Lay a Floor Board on top of Bottom Plates and Joist and push up against end wall. Mark out where Studs are. Cut checkouts with Electric Jigsaw so Floor Board will fit around Studs.



**Step 3:** Re-position Floor Board. Lay out remaining Floor Boards checking around Studs as you go. The last Floor Board may have to be cut to size.



**Step 4:** Nail in each Floor Board, two 50mm nails in each end and two into Joist. Measure and cut Floor Flashing (110) to fit in between Door Jamb Flashings and nail in place using 50mm Clouts.



# KL1 HASP & STAPLE



Using six rivets and one 50mm clout attach hasp to Door Jamb Flashing and the staple to the Door as shown.

(Note: See below for security option.)

# SECURITY DOOR (Optional)

**Step 1:** Attach "T" locking handle with two 8x10mm screws. Slide hook onto square shaft and secure with a lock washer.

Lock Washer

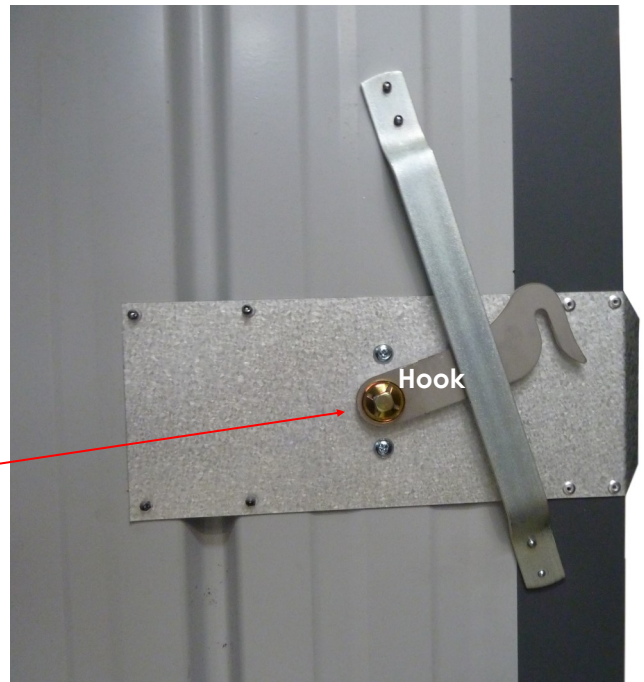

**Step 2:** Once door is hung, position the Locking Stays so they slide into the Locking Brackets easily. Screw Locking Stays to Door Jamb.



## SECURITY DOOR (Optional)

**Step 3:** On the left hand Door Jamb, position latch as shown, at correct height to door handle. Rivet in place with four rivets.



## RAISED FLOOR MODIFICATION

For sheds being placed on a purpose built floor, (concrete, cobbles, ply etc.), the Wall Sheets will protrude 20mm below the Base Plate. This will stop water flowing in between the Base Plate and Floor.

The Floor should be made 15mm smaller than Base Size.

**Note:** Although it is not essential, fitting Damp Proof Course in between the Base Plate and the Floor will give added protection against moisture.

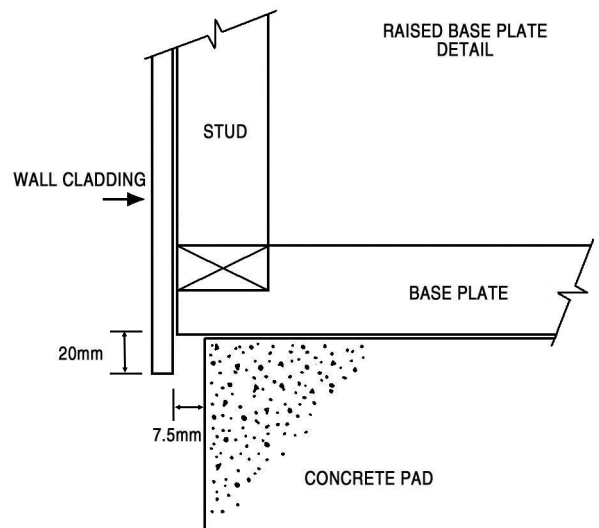

## CLEAN UP

- Remove all swarf (drill filings) with a soft brush or rag.
- Hose down roof and walls thoroughly.
- For Coloursteel sheds use touch-up paint provided on all nail heads, rivets and exposed cuts.



## DURATUF PREMIUM SHED WARRANTY

### GUARANTEE TO CUSTOMER

Congratulations on purchasing a Duratuf Storage Shed. With proper care and attention, this product will last many years. For your benefit **PLEASE READ THE FOLLOWING INFORMATION CAREFULLY.**

### WARRANTY ON METAL CLADDING

Riverlea Group Ltd guarantee that the metal roofing and wall cladding on Kiwi and Fortress Garden Sheds may be used in moderate and inland corrosion zones or areas where the first year mild steel corrosion rate is less than 200g/m<sup>2</sup>, and that in these conditions, they will not perforate due to corrosion within 30 years of date of manufacture.

### TERMS AND CONDITIONS

1. Damage or corrosion due to the following circumstances is not covered by this warranty.
  - ◆ Mechanical, chemical or other damage sustained during or after installation.  
**NOTE:** Clean swarf off shed **IMMEDIATELY** after assembly  
Do **NOT** mark cladding with pencil  
Do **NOT** allow manures, chemicals or other corrosive materials to have direct contact with cladding  
Chemical damage will result if these instructions are not carried out
  - ◆ Force majeure or other causes beyond the control of Riverlea Group Ltd.
2. This warranty does not cover material installed in severe and very severe environmental situations, or in any area where the mild steel corrosion rate (as published by BRANZ) exceeds 200g/m<sup>2</sup>.
3. Minimum maintenance must be carried out in accordance with instructions below.

Should the cladding fail to perform as specified above, the liability of Riverlea Group Ltd shall in all cases be limited to replacing or repairing the defective product. The balance of the original warranty will cover any repaired or replaced material. Riverlea Group Ltd will not be liable for any consequential loss or damage, labour or transport charges. All claims made in writing within 21 days of discovery, quoting the reference number at the top right hand corner of this page.

### MAINTENANCE

Following are the minimum maintenance requirements for cladding used in Kiwi Garden Sheds and Fortress Sheds.

- ◆ Washing all surfaces by rain, and annual hosing of sheltered areas using a hose and soft nylon brush.
- ◆ Within 2km of coast—wash every 3 months as above. After a storm, wash the cladding and the gutters as soon as possible to remove any highly corrosive salt deposits.
- ◆ Volcanic Ash Fallout—wash as soon as possible, removing fallout from roof and gutters
- ◆ Gutters to be kept clean of leaves and dirt.

Should you require additional technical information please contact us at the details below.

## WARRANTY REGISTRATION

Please visit <http://www.riverleagroup.co.nz/warranty-garden-sheds> to validate the Warranty on your shed.

Click on the Warranty Registration Link and complete all details.

If you are unable to access the computer, please phone us on 0800 438 274 and one of the customer services team will help you to activate the warranty on your garden shed.

*Many thanks, from the Team at Riverlea Group.*